



# M15

AV Surround Sound Preamplifier

---

ENGLISH

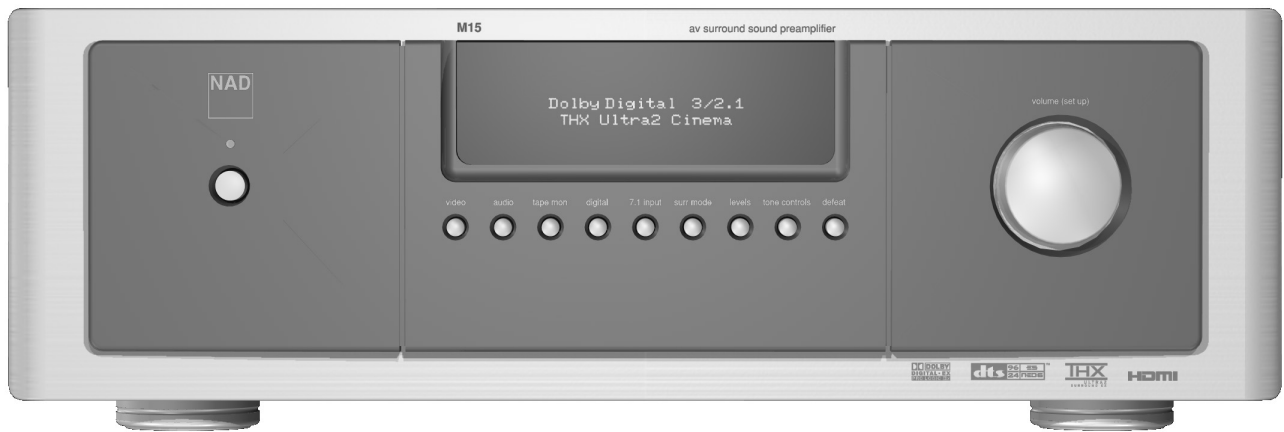

---

Owner's Manual

## IMPORTANT SAFETY INSTRUCTIONS

- Save these instructions for later use.
- Follow all warnings and instructions marked on the audio equipment.

**1 Read instructions** - All the safety and operating instructions should be read before the product is operated.

**2 Retain instructions** - The safety and operating instructions should be retained for future reference.

**3 Heed Warnings** - All warnings on the product and in the operating instructions should be adhered to.

**4 Follow Instructions** - All operating and use instructions should be followed.

**5 Cleaning** - Unplug this product from the wall outlet before cleaning. Do not use liquid cleaners or aerosol cleaners. Use a damp cloth for cleaning.

**6 Attachments** - Do not use attachments not recommended by the product manufacturer as they may cause hazards.

**7 Water and Moisture** - Do not use this product near water-for example, near a bath tub, wash bowl, kitchen sink, or laundry tub; in a wet basement; or near a swimming pool; and the like.



**8 Accessories** - Do not place this product on an unstable cart, stand, tripod, bracket, or table. The product may fall, causing serious injury to a child or adult, and serious damage to the product. Use only with a cart, stand, tripod, bracket, or table recommended by the manufacturer, or sold with the product. Any mounting of the product should follow the manufacturer's instructions, and should use a mounting accessory recommended by the manufacturer.

**9 A product and cart combination** should be moved with care. Quick stops, excessive force, and uneven surfaces may cause the product and cart combination to overturn.

**10 Ventilation** - Slots and openings in the cabinet are provided for ventilation and to ensure reliable operation of the product and to protect it from overheating, and these openings must not be blocked or covered. The openings should never be blocked by placing the product on a bed, sofa, rug, or other similar surface. This product should not be placed in a built-in installation such as a bookcase or rack unless proper ventilation is provided or the manufacturer's instructions have been adhered to.

**11 Power Sources** - This product should be operated only from the type of power source indicated on the marking label. If you are not sure of the type of power supply to your home, consult your product dealer or local power company.

- **Main Power Disconnect;** When the power switch is in the Off position, the preamplifier is not completely disconnected from the main power. The primary method of isolating the preamplifier from the mains supply is to disconnect the mains plug. Ensure that the mains plug remains accessible at all times. When installing the product, ensure that the plug is easily accessible.
- **Non-use Period;** Unplug the AC power cord from the AC outlet if the unit will not be used for a long period of time such as several months or more.
- **CLASS 1 Products;** The M15 shall be connected to a **MAINS** socket outlet with a protective earthing connection.

**12 Power-Cord Protection** - Power-supply cords should be routed so that they are not likely to be walked on or pinched by items placed upon or against them, paying particular attention to cords at plugs, convenience receptacles, and the point where they exit from the product.

**13 Outdoor Antenna Grounding** - If an outside antenna or cable system is connected to the product, be sure the antenna or cable system is grounded so as to provide some protection against voltage surges and built-up static charges. Article 810 of the National Electrical Code, ANSI/NFPA 70, provides information with regard to proper grounding of the mast and supporting structure, grounding of the lead-in wire to an antenna discharge unit, size of grounding conductors, location of antenna discharge unit, connection to grounding electrodes, and requirements for the grounding electrode.

**NOTE TO CATV SYSTEM INSTALLER**

- This reminder is provided to call the CATV system installer's attention to Section 820-40 of the NEC which provides guidelines for proper grounding and, in particular, specifies that the cable ground shall be connected to the grounding system of the building, as close to the point of cable entry as practical.

**14 Lightning** - For added protection for this product during a lightning storm, or when it is left unattended and unused for long periods of time, unplug it from the wall outlet and disconnect the antenna or cable system. This will prevent damage to the product due to lightning and power-line surges.

**15 Power Lines** - An outside antenna system should not be located in the vicinity of overhead power lines or other electric light or power circuits, or where it can fall into such power lines or circuits. When installing an outside antenna system, extreme care should be taken to keep from touching such power lines or circuits as contact with them might be fatal.

**16 Overloading** - Do not overload wall outlets, extension cords, or integral convenience receptacles as this can result in a risk of fire or electric shock.

**17 Object and Liquid Entry** - Never push objects of any kind into this product through openings as they may touch dangerous voltage points or short-out parts that could result in a fire or electric shock. Never spill liquid of any kind on the product.

**18 Damage Requiring Service** - Unplug this product from the wall outlet and refer servicing to qualified service personnel under the following conditions:

- When the power-supply cord or plug is damaged.
- If liquid has been spilled, or objects have fallen into the product.
- If the product has been exposed to rain or water.
- If the product does not operate normally by following the operating instructions. Adjust only those controls that are covered by the operating instructions as an improper adjustment of other controls may result in damage and will often require extensive work by a qualified technician to restore the product to its normal operation.
- If the product has been dropped or damaged in any way.
- When the product exhibits a distinct change in performance-this indicates a need for service.

**19 Replacement Parts** - When replacement parts are required, be sure the service technician has used replacement parts specified by the manufacturer or have the same characteristics as the original part. Unauthorised substitutions may result in fire, electric shock, or other hazards.

**20 Safety Check** - Upon completion of any service or repairs to this product, ask the service technician to perform safety checks to determine that the product is in proper operating condition.

**21 Wall or Ceiling Mounting** - The product should be mounted to a wall or ceiling only as recommended by the manufacturer.

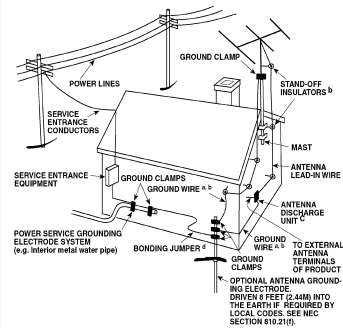

# Introduction

## SAFETY INFORMATION



### WARNING



TO PREVENT FIRE OR SHOCK HAZARD, DO NOT EXPOSE THIS APPLIANCE TO RAIN OR MOISTURE. THE LIGHTNING FLASH WITH ARROWHEAD SYMBOL, WITHIN AN EQUILATERAL TRIANGLE, IS INTENDED TO ALERT THE USER TO THE PRESENCE OF UNINSULATED "DANGEROUS VOLTAGE" WITHIN THE PRODUCT'S ENCLOSURE THAT MAY BE OF SUFFICIENT MAGNITUDE TO CONSTITUTE A RISK OF ELECTRIC SHOCK TO PERSONS.



THE EXCLAMATION POINT WITHIN AN EQUILATERAL TRIANGLE IS INTENDED TO ALERT THE USER TO THE PRESENCE OF IMPORTANT OPERATING AND MAINTENANCE (SERVICING) INSTRUCTIONS IN THE LITERATURE ACCOMPANYING THE APPLIANCE

### CAUTION

Changes or modifications to this equipment not expressly approved by NAD Electronics for compliance could void the user's authority to operate this equipment.

### CAUTION REGARDING PLACEMENT

To maintain proper ventilation, be sure to leave a space around the unit (from the largest outer dimensions including projections) equal to, or greater than, shown below.

Left and Right Panels : 10 cm

Rear Panel : 10 cm

Top Panel : 50 cm

### IMPORTANT INFORMATION FOR UK CUSTOMERS

**DO NOT** cut off the mains plug from this equipment. If the plug fitted is not suitable for the power points in your home or the cable is too short to reach a power point, then obtain an appropriate safety approved extension lead or consult your dealer. If, nonetheless, the mains plug is cut off, REMOVE THE FUSE and dispose of the PLUG immediately, to avoid possible shock hazard by inadvertent connection to the mains supply. If this product is not provided with a mains plug, or one has to be fitted, then follow the instructions given below:

### IMPORTANT

**DO NOT** make any connection to the larger terminal which is marked with the letter 'E' or by the safety earth symbol or coloured GREEN or GREEN AND YELLOW.

The wires in the mains lead on this product are coloured in accordance with the following code:

BLUE - NEUTRAL

BROWN - LIVE

As these colours may not correspond with the coloured markings identifying the terminals in your plug, proceed as follows:

The BLUE wire must be connected to the terminal marked with the letter 'N' or coloured BLACK.

The BROWN wire must be connected to the terminal marked with the letter 'L' or coloured RED

When replacing the fuse, only a correctly rated and approved type should be used, and be sure to re-fit the fuse cover.

### IF IN DOUBT CONSULT A COMPETENT ELECTRICIAN

This product is manufactured to comply with the radio interference requirements of EEC DIRECTIVE 89/68/EEC and 73/23/EEC

### NOTES ON ENVIRONMENTAL PROTECTION

At the end of its useful life, this product must not be disposed of with regular household waste but must be returned to a collection point for the recycling of electrical and electronic equipment. The symbol on the product, user's manual and packaging, point this out.

The materials can be reused in accordance with their markings. Through re-use, recycling of raw materials, or other forms of recycling of old products, you are making an important contribution to the protection of our environment.

Your local administrative office can advise you of the responsible waste disposal point.

### RECORD YOUR MODEL NUMBER (NOW, WHILE YOU CAN SEE IT)

The model and serial number of your new M15 are located on the back of the cabinet. For your future convenience, we suggest that you record these numbers here:

Model No. : \_\_\_\_\_ Serial No. : \_\_\_\_\_



<b>INTRODUCTION</b>	
Safety precautions .....	2-4
Table of contents .....	5
<b>Getting Started</b> .....	6
About THX .....	6
What's In The Box .....	6
Save The Packing .....	6
Dolby .....	6
DTS .....	6
THX .....	6
<b>Quick Start</b> .....	7-9
<b>IDENTIFICATION OF CONTROLS</b>	
Front Panel/Rear Panel .....	10
Remote Controls .....	11
<b>About the M15</b> .....	12-15
Front Panel Controls .....	12
<b>About the HTRM</b> .....	16-21
Getting Familiar with the HTRM .....	16
HTRM SETUP MENU .....	17
Navigation of the HTRM Controls .....	18
HTRM Features .....	19
USB Interface .....	21
<b>About the M15</b> .....	22-26
Rear Panel Connections and Controls .....	22
<b>SETUP</b>	
<b>Using M15</b> .....	27-34
OSD And Monitor Output .....	27
Navigation of the On Screen Display (OSD) Menus .....	27
Audio Control .....	27
THX/Speaker Setup .....	28
THX/Bass Management .....	29
THX/Guidelines .....	29
Source Setup .....	30
Display Setup .....	32
Trigger Setup .....	32
Zone 2/MS Out .....	32
Enhanced Stereo .....	33
AV Presets .....	33
Setting Up Audio Video Presets .....	33
Assigning AV Presets .....	34
Copying AV Presets .....	34
<b>REFERENCE</b>	
<b>Troubleshooting Guide</b> .....	35
M15 Factory Default Settings .....	35
HTRM Special Functions .....	35
<b>Specifications</b> .....	36
<b>Notes</b> .....	37

### ABOUT THX

The M15 AV preamplifier is certified by THX Ltd as meeting the rigorous requirements of its home THX/Ultra 2 program for surround controllers. This means that it is capable of delivering an audio experience equal to that of the finest commercial cinemas when its superb fundamental performance is combined with the surround enhancements mandated by the THX/Ultra 2\* program.

### WHAT'S IN THE BOX:

Packed with your M15 AV Surround Sound Preamplifier you will find:

- A removable AC cable
- The HTRM System remote control with batteries
- The ZR2 second zone remote control with battery
- This Owner's Manual

### SAVE THE PACKING:

Please save the box and all of the packaging in which your M15 arrived. Should you move or otherwise need to transport your AV Surround Sound preamplifier, this is by far the safest container in which to do so. We've seen too many otherwise perfect components damaged in transit for lack of a proper shipping carton, so please: Save that box!

### DOLBY

\*Manufactured under license from Dolby Laboratories.

"Dolby", "Pro Logic", and the double-D symbol are trademarks of Dolby Laboratories.

### DTS

\*"DTS", "DTS-ES", "Neo:6", and "DTS 96/24" are trademarks of Digital Theater Systems, Inc.

### THX

\*"THX" and "Ultra2" are trademarks of THX Ltd. "THX" may be registered in some jurisdictions. All rights reserved. Surround EX is a trademark of Dolby Laboratories. Used with permission.

In case you simply cannot wait to experience the performance of your new NAD M15 AV Surround Sound Preamplifier, we provide the following "Quick Start" instructions to get you underway. Follow the steps below for connecting your DVD player, TV/monitor, and multi-channel amplifier to the M15. (see Figure 2 or Figure 3 depending on the type of TV/monitor used). We strongly advise that all equipment be switched off and have the power cables disconnected from the AC-power before proceeding.

#### FOR TV/MONITORS WITH COMPONENT CONNECTIONS (FIGURE 2)

- Connect the M15's **COMPONENT VIDEO OUT Y-C<sub>b</sub>/P<sub>b</sub>-C<sub>r</sub>/P<sub>r</sub>** jack to your TV/monitor's corresponding input.
- Connect your DVD player's Composite output to the M15's **DVD COMPOSITE VIDEO IN**.

#### FOR TV/MONITORS WITH HDMI CONNECTIONS (FIGURE 3)

- Connect the M15's **HDMI OUT** jack to your TV/monitor's corresponding HDMI input.
- Connect your DVD player's HDMI output to the M15's **HDMI IN 1** jack.

#### AUDIO CONNECTIONS (FIGURE 2 OR FIGURE 3)

- Connect the DVD player's coaxial digital output to the M15's **COAXIAL IN 1** input.
- Connect the M15's **AUDIO PRE-OUT** outputs to your multi-channel amplifier.
- Connect your speakers to the multi-channel amplifier's outputs, being sure to connect red to red ("+") and black to black ("-"), with care to avoid stray wires or strands crossing between terminals. (Connect center, surround, and surround-back speakers as well, if you like). If your system includes a powered subwoofer, connect the M15's **AUDIO PRE-OUT SUBW1** jack to the subwoofer's line input.
- Now connect all power cables from the equipment to the AC-power.
- Switch on the black rocker main **POWER** switch on the M15's rear panel, see Figure 1 (this puts the M15 into Standby mode and illuminates an amber LED to indicate it is ready to receive remote commands), and then press any of the front panel buttons to power up the M15. Be sure the multi-channel amplifier and TV / monitor are powered up, with the correct input selected.
- Start playback of the DVD player. Press the HTRM remote's **AMP DEVICE SELECTOR** button, and then its **DVD1** button to select the DVD input. You should hear multichannel or stereo sound, and see an image on the TV/monitor. (If one or the other fails to appear, you may need to use their preamplifier's on-screen menu system to check assignment of audio, video, and digital inputs. Enjoy the movie or music, but be sure to set aside time to read this manual thoroughly, and to set up, calibrate, and configure your M15 carefully and completely.

**Note:** Coaxial, HDMI, and video interconnect cables are not supplied. Please contact your NAD Dealer for supplying the latest high quality interconnect cables.

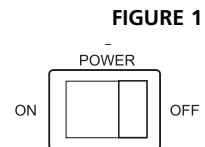
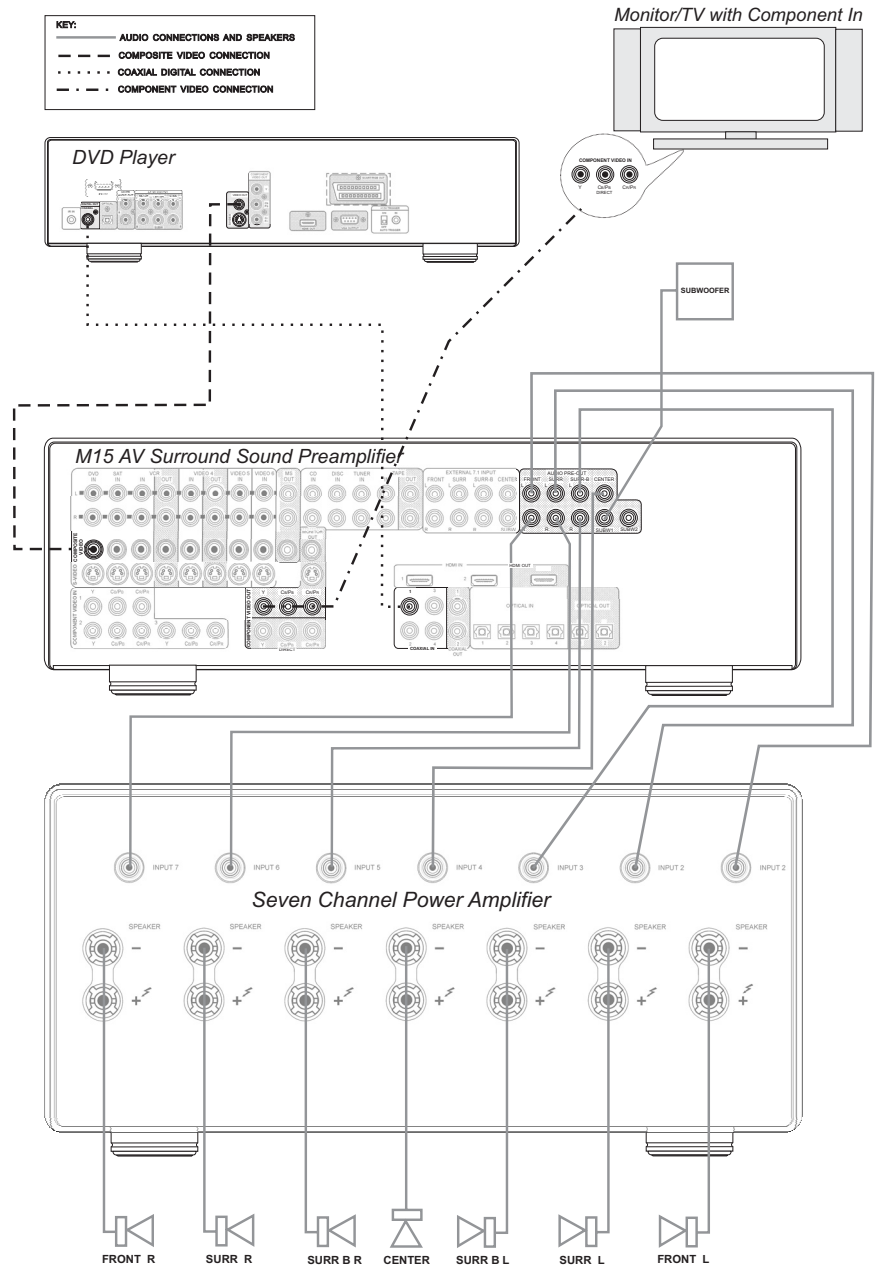

FIGURE 2



**Note:** the M15's OSD is available from all the **MONITOR OUT** sockets except for **DIRECT OUT**



FIGURE 3

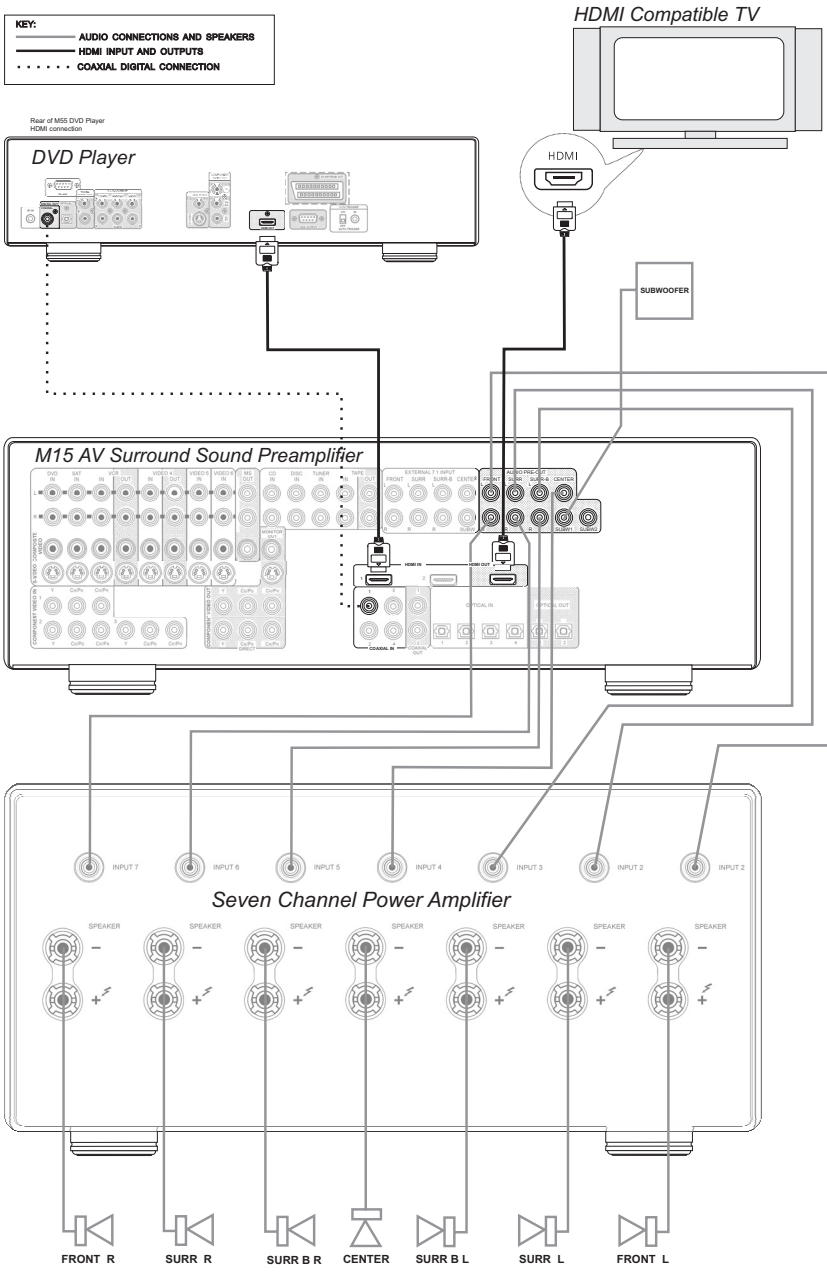

**Note:** the M15's OSD is not available from the **HDMI OUT** socket.

ENGLISH

# Identification of controls

## FRONT PANEL (FIGURE 3)

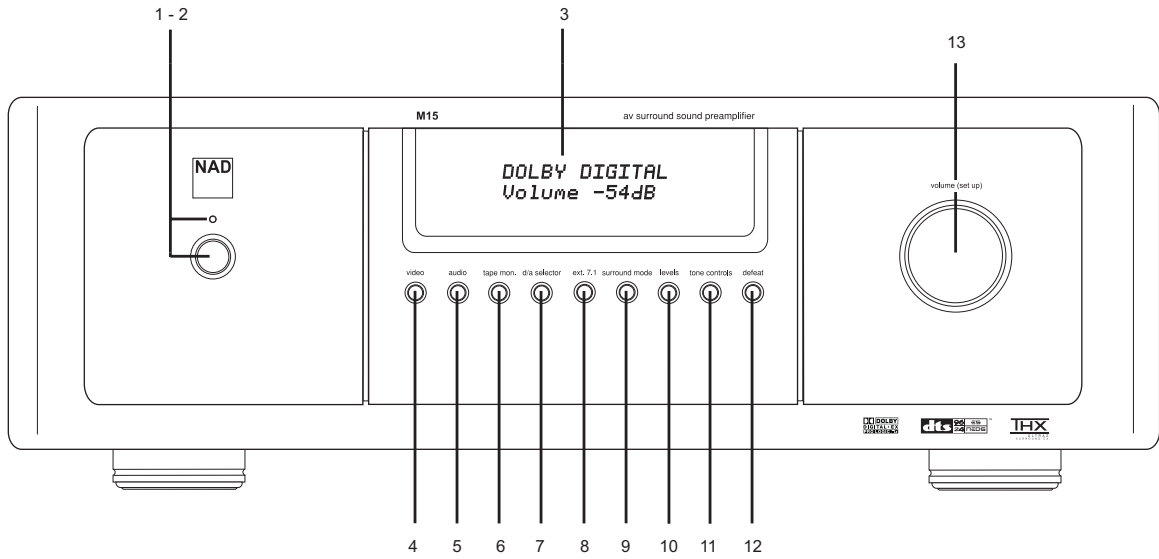

## REAR PANEL (FIGURE 4)

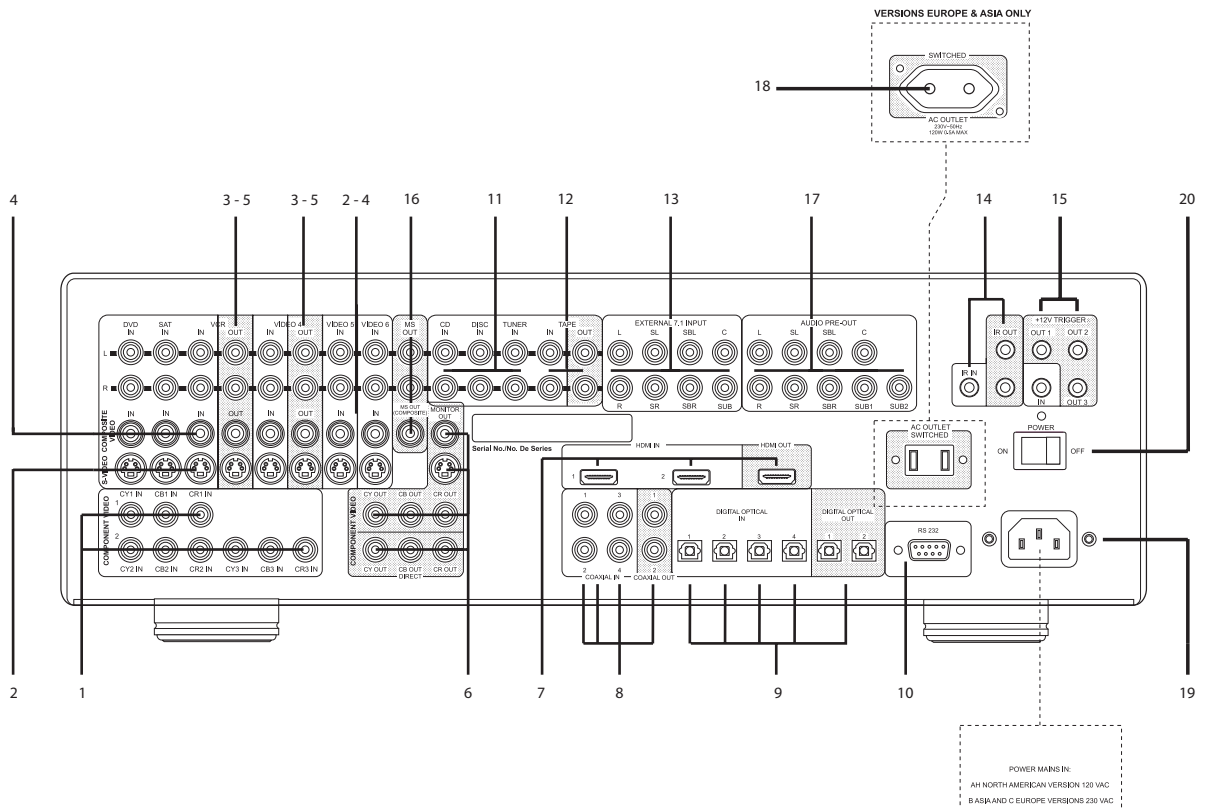

# Identification of controls

## HTRM REMOTE CONTROL (FIGURE 5)

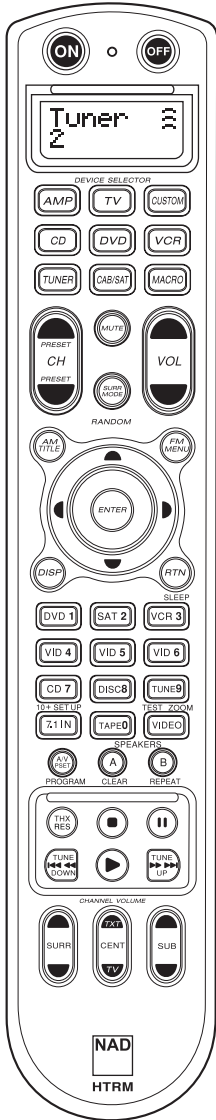

- Top section features **ON/OFF** buttons and back-light LCD display.
- Upper section has eight **DEVICE SELECTOR** keys including one programmable **CUSTOM DEVICE SELECTOR**, one **MACRO** buttons.
- The upper middle section with channel, volume, **MUTE**, surround-mode buttons
- Middle section has DVD, CD and OSD navigation buttons
- Lower middle section has number buttons **0 to 9**, **A/V PSET**, **SPEAKER**, function, DVD **SETUP**, and receiver's Surround Mode **TEST** buttons
- Lower section has DVD/CD/TAPE Transport buttons
- Bottom section with **CHANNEL VOLUME** trimming buttons

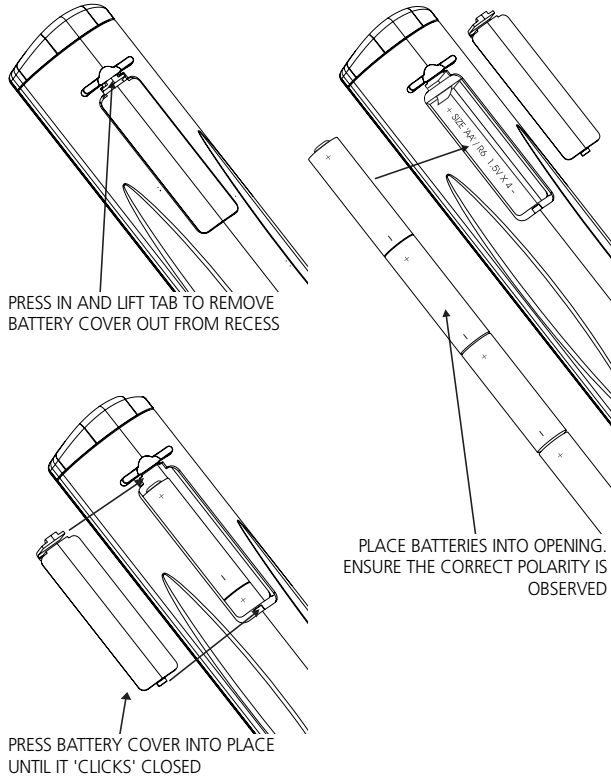

ENGLISH

## ZR2 REMOTE CONTROL (FIGURE 6)

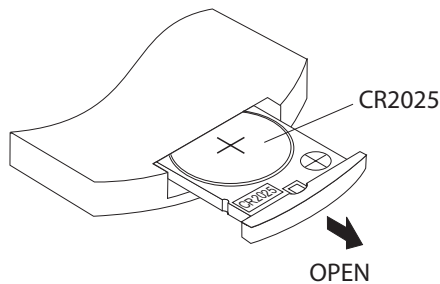
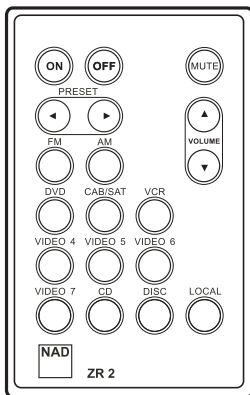

# Identification of controls

## ABOUT THE M15

### FRONT PANEL CONTROLS

#### DIAGRAMMATIC REPRESENTATION OF THE FRONT PANEL CONTROLS

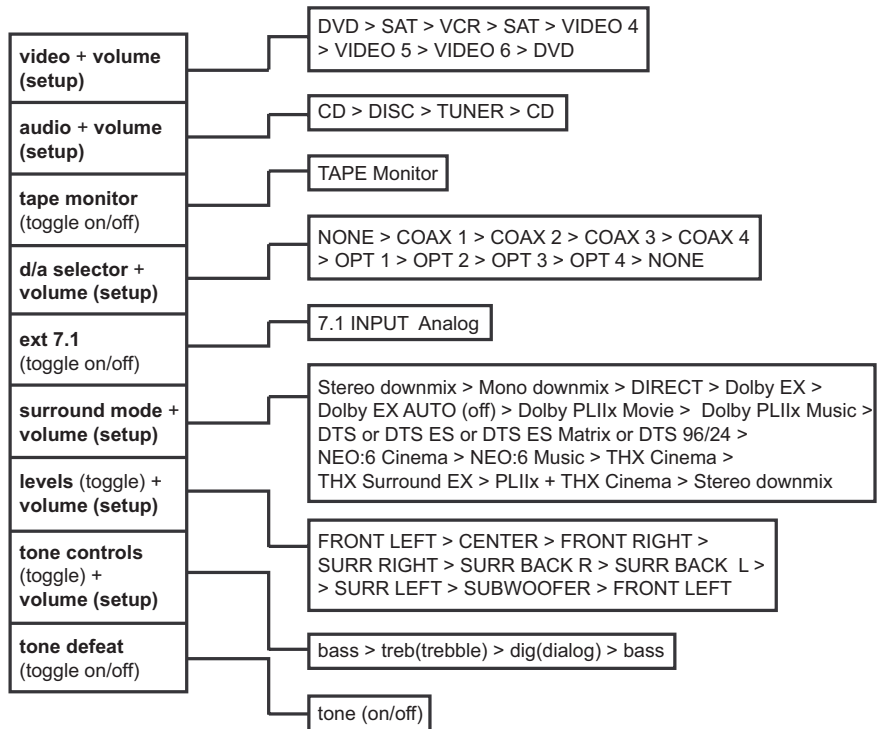

- 1. Power:** Switch on and off to enter and exit the Standby mode. The rear panel **POWER** switch must be in the **ON** position for the M15 Power switch to activate.
- 2. Standby LED:** Illuminates blue when the M15 is in the On mode (Amber when the M15 is in standby).
- 3. Vacuum Florescent Display (VFD):** The VFD provides visual information on all of the M15's important modes, settings, and functions for both main and **MS OUT** locations.
- 4. video:** Press and hold while simultaneously using the **volume (set up)** knob to sequentially select video inputs. The inputs available are; DVD, SAT, VCR, Video 4, Video 5, Video 6, and then return to DVD.
- 5. audio:** Press and hold while simultaneously using the **volume (set up)** knob to sequentially select audio inputs. The inputs available are: CD, DISC, TUNER, and then back to CD.
- 6. tape mon.:** Press to engage the Tape Monitor loop. The signal present at the rear-panel **TAPE MONITOR IN** jacks will be heard.
- 7. d/a selector:** Press and hold while simultaneously using the **volume (set up)** knob to sequentially select digital inputs. The digital inputs available are; NONE, COAX 1, COAX 2, COAX 3, COAX 4, OPT 1, OPT 2, OPT 3, OPT 4, then back to NONE. There are four coaxial as well as four optical inputs.

**Note:** This association is temporary. The M15 will revert to the settings made in the OSD, if the M15 was switched to standby or to another source.

**8. ext. 7.1:** Press to select the **7.1 CH AUDIO IN** analog inputs. These inputs bypass the M15's processor. Tone controls are not available with this input, only Volume control.

**9. surround mode:** Press and hold while simultaneously using the **volume (set up)** knob to sequentially select the surround modes. Depending on the speaker setup, format, and signal type some surround modes may not be made available.

The following are all the possible decoding and post processing options for 2-channel PCM 96kHz with THX option turned on or off. See figure A

The following are all the possible decoding and post processing options for analog inputs and 2-channel PCM 44.1kHz, 2-channel PCM 48kHz, Dolby Digital 2.0 and DTS 2.0, with THX option turned off. See figure B

**Note:** if the surround back speakers are set to "none" then Dolby PLIIx Movie and Music will be replaced with PLII Movie and Music.

The following are all the possible decoding and post processing options for analog inputs and 2-channel PCM 44.1kHz, 2-channel PCM 48kHz, Dolby Digital 2.0 and DTS 2.0, with THX option turned on. See figure C

**Note:** if the surround back speakers are set to "none" then PLIIx + THX and PLIIx Music will be replaced with PLII + THX and PLII Music.

The following are all the possible decoding and post processing options for Dolby digital 5.1 inputs with THX option turned off. See figure D

**Notes:** if the surround back speakers are set to "none" then Dolby Surround EX, Dolby PLIIx Movie and Music will be skipped.  
if the surround back speakers are set to "1 LARGE" or "1 SMALL" then Dolby Surround EX and Dolby PLIIx will be available.

Figure A

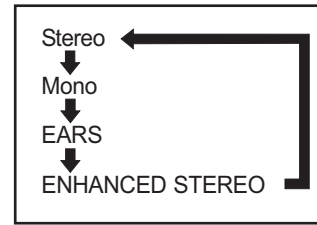

Figure B

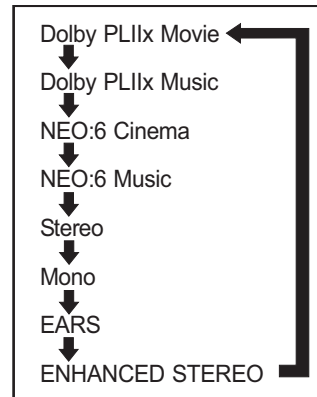

Figure C

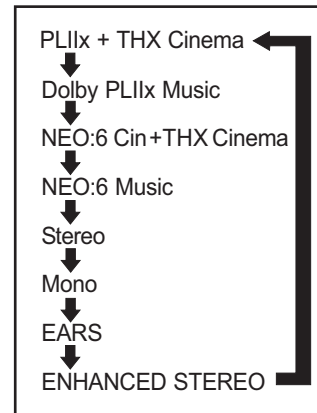
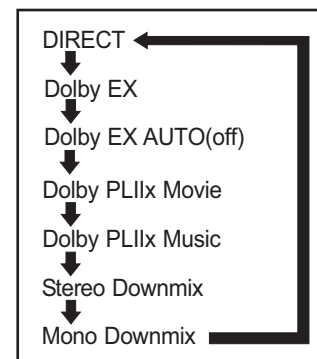

Figure D



# Identification of controls

## ABOUT THE M15

ENGLISH

Figure E



The following are all the possible decoding and post processing options for Dolby Digital 5.1 inputs with THX option turned on. See figure E

**Notes:** if the surround back speakers are set to "none" then THX Surround EX, PLIIx + THX Cinema, and THX Ultra2 Cinema, will be skipped, but THX Cinema will then become available.

if the surround back speakers are set to "1 LARGE" or "1 SMALL" then Dolby Surround EX, PLII x Music and PLIIx Movie will be available.

The following are all the possible decoding and post processing options DTS 5.1 inputs with THX option turned on. See figure F

**Notes:** if the surround back speakers are set to "none" then THX Surround EX, PLIIx + THX Cinema, and THX Ultra2 Cinema, will be skipped, but THX Cinema will become available.

Figure F

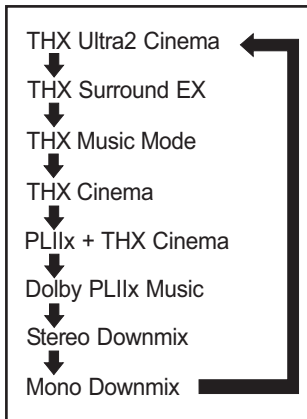

The following are all the possible decoding and post processing options for DTS 6.1 ES Discrete and Matrix inputs with THX option turned off. See figure G

The following are all the possible decoding options DTS 6.1 ES Discrete and Matrix inputs with THX option turned on. See figure H

**Note:** if the surround speakers are set to "none" then THX Cinema will be skipped.

The following are all the possible decoding and post processing options for DTS 6.1 ES Discrete inputs with THX option turned off..See figure G.

The following are all the possible decoding and post processing options for DTS 6.1 ES Discrete inputs with THX option turned on. See figure H

**Note:** if the surround speakers are set to "none" then THX Cinema will be skipped.

Figure G

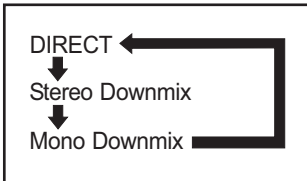
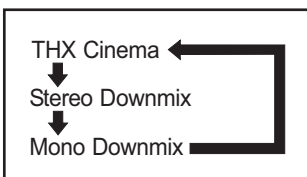

Figure H



**10 levels:** Press to access the VFD menu on the front-panel read-out, and to select speaker levels using the **volume (set up)** knob and subsequent presses of the levels key. Each press of the levels key will advance from one speaker to the other as follows; Front Left, Center, Front Right, Surround Right, Surround Back Right, Surround Back Left, Surround Left, Subwoofer, then back to Front Left.

**Note:** Any speakers set to "NONE" will be skipped

**11. tone controls:** Press to adjust treble using the **volume (set up)** knob; press again to adjust bass, and a third time to adjust dialog pitch adjustment. Tone controls will only take effect when the tone controls are toggled ON via the **defeat** button or set to ON in the OSD.

**Notes:** Tone controls are reset to 0.0dB every time the M15 is turned off  
Tone controls only affect front left and right speakers.

**12. defeat:** Press to toggle between tone controls ON and tone controls OFF. Note that if one is in THX mode, Tone controls will be automatically disabled.

**13. Volume (Setup):** Turn clockwise to increase the master-volume setting; counterclockwise to lower it. The VFL and on-screen displays show the setting, displayed in decibels between Mute to +12dB.

The **Volume (Setup)** knob is also used to increment/decrement individual channel levels and other adjustable parameters.

# Identification of controls

## ABOUT THE HTRM

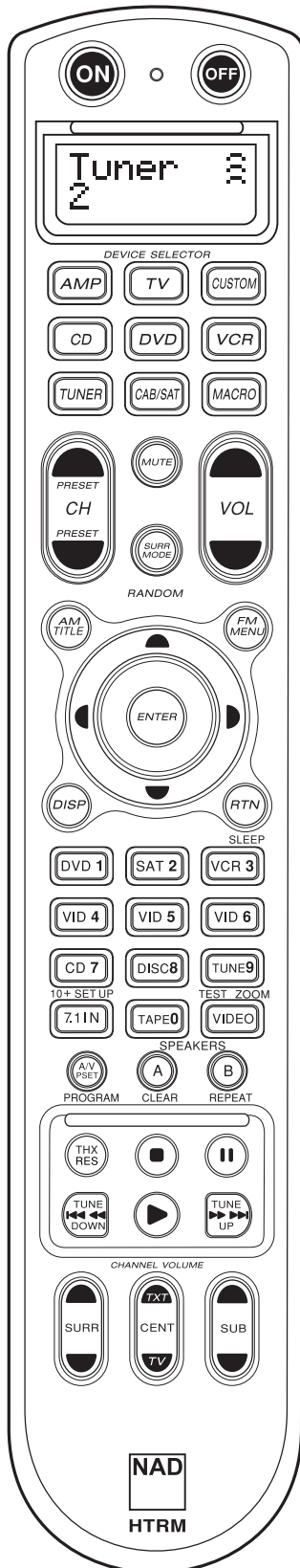

### INTRODUCTION

The HTRM is like having eight virtual remote controls in one. The eight **DEVICE SELECTOR** keys can be used to switch between the different virtual remote controls or devices. When the HTRM is idle, the name of the currently selected device will be shown on the first line of the LCD display. Whenever a function key is pressed, the name of that function will be shown on the second line of the LCD display. The second line will be cleared again shortly after releasing the function key.

### THE HTRM HAS A TOTAL OF 53 KEYS:

- Controls up to 8 Devices
- 2-line LCD display indicates selected Device (DVD) and sent Command (PLAY) (for example)
- Preprogrammed with all NAD remote commands including Zone 2
- Learning function - learns up to 360 commands from other remotes
- Macro operations - program up to 52 Macros with as many as 64 commands each to automate commonly used command sequences
- Punch Through Operations permit easy access to commonly used functions without reselecting a device
- Full illumination with light sensor and adjustable time out for easy operation in low light conditions
- Can generate IR signals with a carrier frequency up to 500 kHz (B&O® compatible)
- Mini USB PC Interface allows programming from a Personal Computer

The HTRM is already preprogrammed with a full complement of NAD commands on its AMP DEVICE SELECTOR page, and with library commands to operate most NAD DVD, CD, TUNER, or TAPE components on the corresponding DEVICE SELECTOR keys. These default commands are permanent: Even if you teach the HTRM new commands to take their place, the underlying library commands remain in place and can easily be recalled should you add an NAD component to your system later.

### GETTING FAMILIAR WITH THE HTRM

The HTRM is divided into three main sections. The LCD display section at the top of the handset, the **DEVICE SELECTOR**, and the remaining 44 Control keys. (see Figure 5)

Eight **DEVICE SELECTOR** keys at the top; **AMP**, **TV**, **CUSTOM**, **CD**, **DVD**, **VCR**, **TUNER**, and **CABLE/SAT** determine which component the remaining 44 control keys will operate. A **DEVICE SELECTOR** key determines what component the HTRM will command; with factory defaults, it does not perform any function on the receiver. The **DEVICE SELECTOR** keys are organised into three vertical rows of 3 buttons each; the row on the left are all Audio devices, the row in the center are all Video devices.

Both the **DEVICE SELECTOR** and function keys that can “learn” control codes from virtually any infrared remote controller, allowing you to teach the codes of your equipment, regardless of brand, to the HTRM. All of the function keys on the **AMP DEVICE SELECTOR** are preprogrammed to control NAD amplifiers, preamplifiers, and receivers. (The HTRM can also command many other NAD components, from its **DVD**, **CD**, **TUNER** and **TV** pages.)

Since HTRM Control keys can perform different functions, depending on the selected **DEVICE SELECTOR** key, the HTRM uses colour coding to indicate the function of the function keys when different device keys are chosen. Thus, the colour of the **DEVICE SELECTOR** key-labelling corresponds to the labelling of the function keys (similar to a calculator). For example, the red-grey **AMP DEVICE SELECTOR** key label corresponds to the grey input-select labelling adjacent to the numeric keys: When the HTRM's **AMP DEVICE SELECTOR** page is active, these keys select the amplifier or receiver inputs. Similarly, the red **DVD DEVICE SELECTOR** key label corresponds to several red labels, the green **TV DEVICE SELECTOR** key to green labels, and so on.



# HTRM – Setup Menu

## General Menu Operation:

- Press and hold **SETUP+ ENTER** for 5 seconds to enter setup menu.
- The **MACRO** key is a cancel function in all setup modes unless otherwise noted.
- You can exit menus by selecting Exit or pressing the **MACRO** key.
- Use **Up** and **Down** cursor keys to select different menu items. An Up/Down arrow will be shown on the display when this action is available.
- For options which can be changed, the **Right** and **Left** keys are used to cycle through the available options. Left and Right arrows will be shown on the display to indicate when an option can be changed.
- Press **ENTER** to select a menu option or confirm a value.

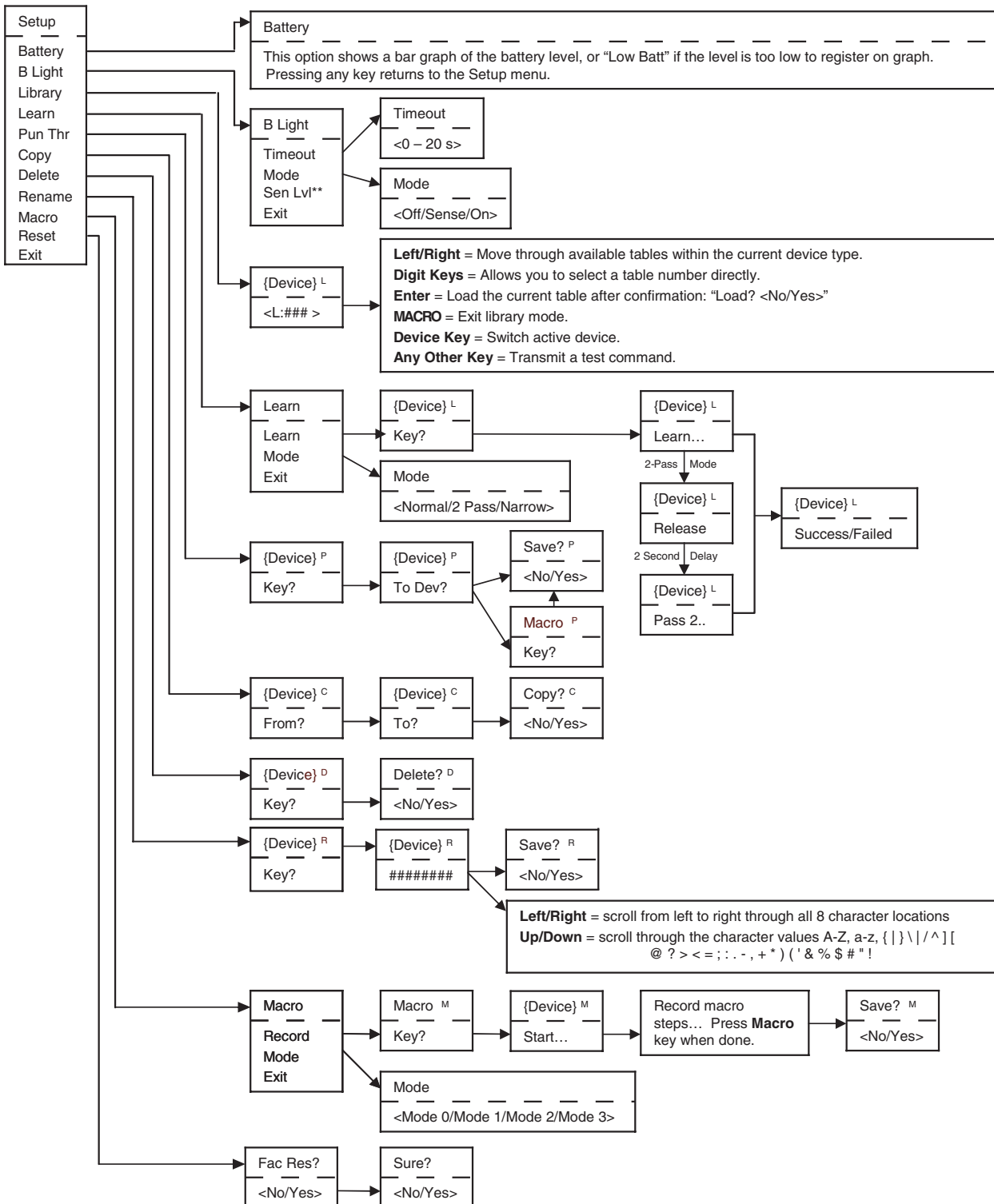

**\*\*WARNING!** Sen Lvl is an adjustment that may lessen battery life. Refer to HTRM Special Features for adjustment.

### BACKLIGHT

The HTRM is equipped with a backlight to increase visibility of the HTRM in low light conditions. The HTRM also includes a light sensor. By default, if you press any key on the remote and it senses a low light condition, the back light will turn on. It will then turn off again five seconds after no key has been pressed.

The behaviour and timeout for the backlight can be adjusted. (Refer to the "HTRM Features" for further information.)

### LOW BATTERY WARNING

If the HTRM senses the batteries are low, it will show "**Low Batt**" on the second line of the LCD display whenever the remote is idle. When this occurs the batteries should be replaced with new ones immediately.

### DEVICE SELECTOR KEYS

Simply pressing a **DEVICE SELECTOR** key will change the active device on the HTRM. At this time, no IR commands will be transmitted. The name of the selected device will be shown on the first line of the LCD display.

**Note:** Any IR command can be associated with a **DEVICE SELECTOR** key during "Copy" and "Learn" modes. Once the associated function is assigned to the **DEVICE SELECTOR** key pressing and holding the **DEVICE SELECTOR** key for more than two seconds will send the associated command in addition to the HTRM switching its active device.

## NAVIGATION OF THE HTRM CONTROLS

### MACRO KEYS

A macro can be associated with every key on the HTRM except for the MACRO button itself. A total of 52 macros can be stored.

To execute a macro:

- Press the **MACRO** key. The first line of the LCD display will show "MACRO".
- Within five seconds, press the key the macro is associated with.
- While the macro is executing a small "M" will be shown in the top right of the LCD display. (refer to the Setup Menu section for information on how to setup macros)

### FUNCTION KEYS

There are 44 dedicated function keys on the HTRM. When you press a function key, the name of the function will be shown on the second line of the LCD display while the command is being transmitted.

### A/V PSET KEY

In the default configuration of the HTRM, the **A/V PSET** key acts as a shift function when the AMP device is selected. Pressing the **A/V PSET** key once will cause "Preset" to be displayed on the first line of the LCD display. If within five seconds you then press a digit 0 - 9, the function for the corresponding AV Preset will be transmitted.

**Note:** The HTRM is an universal-type remote control, some NAD receivers may not have more than 5 AV presets.

### SETUP MENU

Press and hold the **SETUP** and **ENTER** keys for five seconds to enter the Setup Menu. You cannot enter the setup menu if the remote is currently displaying "Low Batt". This feature prevents the setup from becoming corrupted under low battery conditions.

Please refer to Setup Navigation for the overall structure and basic operation of the Setup Menu.

**HTRM FEATURES:****BATTERY**

Instead of waiting until the "Low Batt" warning is displayed, you can check the current battery level using this option. This option will show a bar graph representing the current battery level. When the batteries are new, the bar graph will show 8 bars, Once the bar graph reaches close to zero, the "Low Batt" warning will start to show.

**BACK LIGHT SENSITIVITY (B LIGHT)**

The backlight timeout can be set from 0 - 20 seconds. This is the length of time the backlight stays on after releasing the last key.

The following backlight modes are available:

- Off - The backlight will never come on.
- Sense - The backlight will only come on if the light sensor detects low light conditions.
- On - The backlight will come on any time a key is pressed.
- Sense Level - The point where the back light comes on in a darkened room

**LIBRARY**

This function allows you to set all the function keys for a device to the functions stored in the included library tables.

**LEARN**

This function allows you to learn IR commands from another remote.

To learn a function into a **DEVICE SELECTOR** key press the desired **DEVICE SELECTOR** key momentarily and then press and hold the same key for more than two seconds.

**PUNCH THROUGH**

There are two types of punch through functions.

The first type allows a function key to punch through to another device. For example, by default, the volume keys for the DVD device punch through to AMP.

The second type allows you to punch through to a stored macro. This provides a way to execute a macro with a single keys press.

If a macro step includes a key which has a punch through to another macro, the punch through is not used. This is to prevent circular macros that would never end. Instead of the punch through, the underlying function of the key will be used when the macro is executed. This allows you set a single key press macro for a key without losing the original functionality of that key. For example; you could record a macro which includes AMP power on, TV power on and DVD power on and then have the AMP power on button activate this macro.

### **COPY**

This function allows you to copy functions from one key to another. If you want to select a **DEVICE SELECTOR** key for either the "From?" or "To?" you must press and hold the key for two seconds. Just pressing the key momentarily will only change the active device.

### **DELETE**

Each key can have several functions types stored. However, only the highest priority type will be active. When you delete a function, a lower priority function type may become active. To completely erase the functionality of a key, you may need to execute the Delete function multiple times.

For example; if you delete a learned command, a lower priority command may become active. The order of priority for each function type are:

- Punch Through
- Learned
- Copied Library Command
- Default Library Command

To delete the function from a **DEVICE SELECTOR** key you must press and hold the key for two seconds. Just pressing the key momentarily will only change the active device.

### **RENAME**

All keys can be renamed except the **MACRO** key. In the RENAME menu, first press the **DEVICE SELECTOR** key then the function key; the second line of the LCD will be blank ready to accept the alpha-numeric characters. Use the navigation arrows to select the alpha-numeric characters, and then press the **ENTER** key. Select "Save" and then "Yes" to store the new name.

**Note:** There are a maximum of eight segments available for the alpha-numeric characters.

### **MACRO**

While recording macros, the HTRM will function as normal except there will be a small "M" in the top right of the LCD display, and IR commands are transmitted the same as during normal operation.

Macros will be executed with the same timing as they were recorded. The length of time each command is sent will also correspond to the length of time the key was held down for while recording.

By default, when a macro is executed, the currently selected device will be returned to what it was before the macro was executed. However, if the very last button pressed while recording a macro is a **DEVICE SELECTOR** key, the device will be changed at the end of executing the macro.

### **RESET**

Selecting this option and answering "Yes" to both confirmations will reset all HTRM options to the factory default values.

**Note:** resetting the HTRM to the factory default settings will erase all user configurations, macros, and custom device programming.

### USB INTERFACE

The HTRM allows one to upload and download the configuration through a Windows PC and NAD's Proprietary HTRM programming software. See Figure 8 on how to connect an USB A male to mini USB B male 5-pin cable to the HTRM.

**NOTES:** Please log onto [www.nadelectronics.com](http://www.nadelectronics.com) for the latest HTRM interface control software.

Use an USB A male to mini USB B male 5-pin cable between your Windows® PC and the HTRM.

Your custom installer or dealer can assist you in the proper setup and configuration of the mini USB interface and software.

The mini USB B male 5-pin cable is not supplied with the HTRM. Your custom installer or dealer can assist you in the procurement of the USB A male to mini USB B male 5-pin cable.

Figure 8

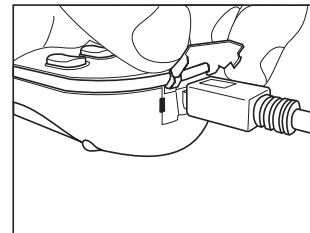
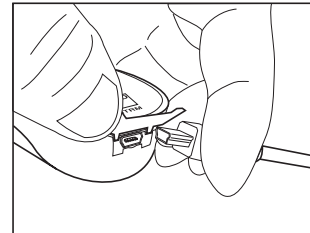
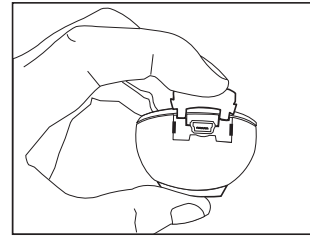

### REAR PANEL CONNECTIONS AND CONTROLS

#### WARNING!

Make all connections to your M15 surround sound preamplifier with the unit powered off and unplugged from the AC power. Furthermore, unplug all auxiliary components' AC power before making or breaking any signal connections.

- 1. COMPONENT VIDEO IN (YUV):** Connect inputs to component-video signal or wide-band component video from a source component such as a DVD-player or HDTV satellite/cable box. Be sure to observe consistency in connecting the **Y**, **C<sub>B</sub>/P<sub>B</sub>**, and **C<sub>R</sub>/P<sub>R</sub>** jacks to the corresponding sources/inputs. **COMPONENT VIDEO IN** may be configured via the M15's OSD menu.
- 2. S-VIDEO IN:** Connect S-Video inputs **DVD**, **SAT**, **VCR**, **VIDEO 4** through **VIDEO 6** from source components. Configuration of the S-Video inputs is through the M15's OSD menu.
- 3. S-VIDEO OUT:** There are two S-Video record outputs, **VCR** and **VIDEO 4**. Connect to S-Video record inputs of recording components.
- 4. COMPOSITE VIDEO IN (CVBS):** Connect to composite video inputs **DVD**, **SAT**, **VCR**, **VIDEO 4** through **VIDEO 6** to composite video from the source components. Configuration of the video inputs is through the M15's OSD menu.
- 5. COMPOSITE VIDEO OUT (CVBS):** There are two composite video record outputs, **VCR** and **VIDEO 4**. Connect to composite-video record-inputs of recording components.
- 6. MONITOR OUT (video out):** All video inputs (CVBS, S-Video, YUV) are available from these outputs. You can connect either of these outputs to your monitor/HDTV. CVBS video and S-Video inputs up-converts to YUV video out. Configuration of the **MONITOR OUT** video is through the M15's OSD menu.

**Note:** The OSD is not available on the **HDMI OUT** output

Both S-Video and composite video inputs are format converted to both the Component video outputs. Selection of the format is through the M15's OSD menu.

The **DIRECT COMPONENT VIDEO OUT** is a direct pass-through component video signal without the M15's OSD.

NAD recommends that one connects the **DIRECT COMPONENT VIDEO OUT** YUV to your monitor for NTSC (North American) video formats 480p/720p/1080i, and PAL (European) video formats 576p/720p/1080i.

#### M15 VIDEO SWITCHING LOGIC

The M15 was optimized for Component Video (YUV) output. Composite (CVBS) and S-Video (SV) sources may be viewed in their native format or via the Component Video (YUV) output.

	Monitor Type	Monitor Type	Monitor Type
	YUV Output	S-Video Output	CVBS Output
CVBS Input	YES	NO	YES
S-Video Input	YES	YES	NO
YUV Input	YES	NO	NO

**Note:** Monitor type selection is limited to a valid input signal type selected.

**7. HDMI IN/OUT:** Connect inputs to the **HDMI** connector of the source component such DVD-player or HDTV satellite/cable box. Connect the output to a HDTV or projector with HDMI input. (See figure below)

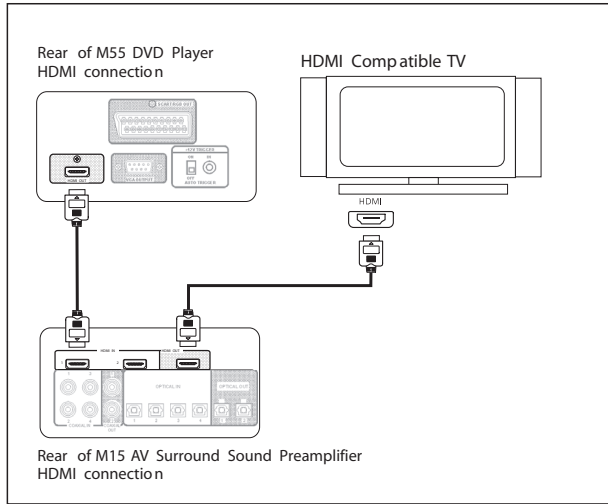

**Note:** HDMI IN and OUT are direct pass-through signal without OSD.

**8. COAXIAL IN/OUT:** Connect **COAXIAL IN** to RCA coaxial sources such as CD, DVD-player, or Cable/Satellite decoder. Connect the **COAXIAL OUT** to RCA coaxial input of a recording component. Configuration of the **COAXIAL IN** and **OUT** association is through the M15's OSD menu.

**9. OPTICAL IN/OUT:** Connect **OPTICAL IN** to optical S/PDIF-format digital sources such as CD or DVD-players. Connect **OPTICAL OUT** to the optical S/PDIF digital input of a recording component such as a CD recorder, DAT deck, or computer. Configuration of the **OPTICAL IN** and **OUT** association is through the M15's OSD menu.

**10.RS-232:** Using a Windows® operating system personal computer, one can remotely control the M15 with NAD's proprietary interface control software. This remote control facility employs a functional image of the M15's front panel as the GUI (graphical user interface). This connector is a standard DB-9 RS-232 configuration. Use an "off-the-shelf" DB-9 RS-232 serial cable to connect between your Windows® PC's DB-9 RS-232 connector and the M15's **RS-232** connector.

**Notes:** Please log onto [www.nadelectronics.com](http://www.nadelectronics.com) for the latest M15 interface control software.

Use a standard DB-9 male to DB-9 female RS-232 serial cable between your Windows® PC and the M15.

Do not use a null-modem type of RS-232 cable.

Some Windows® PC's may not have RS-232 serial connector. In this event, use a standard "off-the-shelf" RS-232 to USB adaptor to connect to your Windows® PC. Follow the instructions that come with the RS-232 to USB adaptor for setting up the adaptor.

Your custom installer or dealer can assist you in the proper setup and configuration of the RS-232 interface.

Neither a DB-9 RS-232 serial cable nor a RS-232 to USB adaptor is supplied with the M15.

DB-9 Pin #	Function
2	Transmit Data
3	Receive Data
5	Signal Ground

**DB-9 pin-out Assignment**

## Identification of controls

### ABOUT THE M15

- 11. CD, DISC, TUNER Inputs:** Connect to stereo analog outputs of audio components.
- 12. TAPE IN/OUT:** Connect **TAPE OUT** to the analog recording component's stereo analog inputs, and **TAPE IN** to the analog recording component's stereo analog outputs. Suitable components would be cassette deck, CD-recorder, or auxiliary analog audio processor.
- 13. EXTERNAL 7.1 INPUTS:** Connect to the corresponding analog audio outputs of a multi-channel source component such as a DVD-Audio or multi-channel SACD player. There are neither bass/treble controls nor other audio processing available for these inputs. (See figure below)

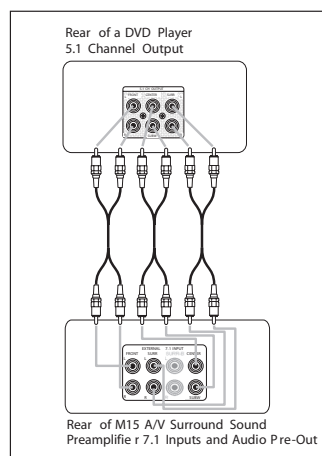

- 14. IR IN/OUT:** There are two 3.5mm **IR OUT** and one **IR IN** jacks. Connect to the corresponding 3.5mm IR jacks (input to output and vice versa) of compatible infrared receiver/transmitter components. Your custom installer or dealer can assist you in the proper setup and configuration of the infrared cables and equipment interface.
- 15. +12 V TRIGGER OUT/IN:** There are three configurable +12V trigger outputs. These **+12V TRIGGER OUT** can follow the powered state of the M15. Use this 3.5mm mini-jack connector to pass +12 volts at a maximum current of 50 milliamps to auxiliary equipment such as a multichannel amplifier or subwoofer. Configuration of the trigger level and duration for each output is through the M15's TRIGGER SETUP OSD menu. The **+12 V TRIGGER IN** is setup in the TRIGGER SETUP OSD. When set to ON, a +12V signal will turn on the M15 from standby.

**Note:** The centre conductor (hot) of the 3.5mm jack is the control signal. The outside conductor (shield) is the ground return-path. Your custom installer or dealer can assist you in the proper setup and configuration of the +12V **TRIGGER OUT/IN** interface and cables.



- 16. MS OUT (zone 2):** Connect to the inputs of the stereo amplifier (an amplifier with or without a volume control) for the second zone location. Connect **COMPOSITE VIDEO MS OUT** and L/R audio to your zone AV Receiver. (See example below).

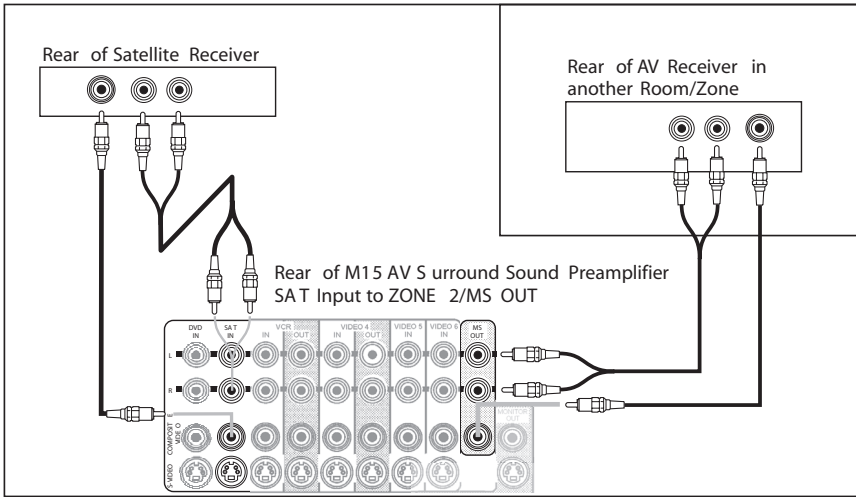

- 17. AUDIO PRE-OUT:** Connect **L** (front left channel), **R** (front right channel), and **C** (center) to the channel inputs of the power amplifiers driving the front channels. Connect **RS** (right surround) and **LS** (left surround) to the power amplifier driving the surround speakers and **SBR** (surround back right) and **SBL** (surround back left) to that driving the surround-back speakers. Finally, connect **SUB1/2** to the line input of a powered subwoofer or to the amplifier driving a passive subwoofer. Configuration of the speaker level, size, and distance is through the M15's OSD menu.

- 18. SWITCHED (Power Socket):** Insert the power cable from auxiliary equipment that is to turn on or off when the M15 is powered on or off using the POWER (vacation switch).

## Identification of controls

### USING THE M15

**19. IEC Power Cable Socket:** Attach the M15's power cable to this IEC socket first, before connecting the power cable to the AC-mains outlet. Never disconnect the power cable from the IEC socket before disconnecting the power cable from the AC-mains outlet. Failure to follow this procedure may result in a possible electric shock hazard. Always make sure that the POWER switch is in the OFF position and disconnect the power cable from the AC-mains outlet, before disconnecting or changing input connections on the back panel. Failure to follow this procedure may result in possible damage to the either the M15 or other auxiliary equipment.

**Note:** When connecting or disconnecting audio cables from the back panel of the M15, disconnect any auxiliary equipment from their AC-mains outlets as well. Failure to follow this procedure may result in possible damage to the either the M15 or other auxiliary equipment.

**20. POWER switch:** The **POWER** switch supplies the master AC mains power for the M15. When this switch is in the **ON** position the M15 is in standby as shown by the amber Status Condition L.E.D. above the standby switch on the front panel. If you intend not to use the amplifier for long periods of time (such as when on vacation), switch the **POWER** switch to the **OFF** position.

**Note:** When the **POWER** switch is in the **OFF** position, neither remote control ZR 2, HTR-M, nor the front panel Power switch will activate the M15.

### OSD AND MONITOR OUTPUT

There are three outputs that contain the M15 OSD. These are **MONITOR OUT** CVBS, S-Video, and YUV. There are two versions of OSD, SIMPLE and FULL. Each will be superimposed over an existing video source.

### NAVIGATION OF THE ON SCREEN DISPLAY (OSD) MENUS

There are seven main On Screen Menus (OSD); Audio Control, THX/SPEAKER SETUP, SOURCE SETUP, DISPLAY SETUP, TRIGGER SETUP, ZONE 2/MS Out, and A/V PRESETS. To enter the OSD, press the HTRM's **ENTER**. Use the **▼** and **▲** to select the submenu and press **▶** to enter the submenu. Use the **◀** to back out of submenus and menu variables without saving changes.

**Notes:** Some menu options feedback direct real-time responses not requiring one to press the **ENTER** button to save the selection.  
Some menu lines are titles that do not have variables in them.

### AUDIO CONTROL

The Audio Control menu has nine submenus, BASS, TREBLE, CENTER DIALOG, TONE CONTROLS, ENHANCED BASS, AUDIO DELAY, LFE LEVEL, THX AUTO, and then ENHANCED STEREO submenus.

### BASS, TREBLE, CENTER DIALOG, AND TONE CONTROLS ON/OFF

These three level controls are arbitrary. These controls allow one to tweak on-the-fly the frequency response of the source during playback in the AUDIO CONTROL OSD menu in conjunction with the HTRM's **TONE** button and the navigation buttons. Maximum and minimum values for BASS and TREBLE are +/- 10.0dB, for CENTER DIALOG they are +/- 6dB.

**Notes:** BASS, TREBLE and CENTER DIALOG are available for surround sound sources with THX off.  
Tone controls are not stored in memory, but are reset every time the M15 is switched to standby.  
Turning off the tone controls bypasses all tone controls filters.  
Tone controls are available on the front left, right and center speakers.

### LFE LEVEL AND ENHANCED BASS

LFE adjustment allows one to decrease the level of Low Frequency Effect encoding of digital source materials. This helps in conjunction with the SPEAKER LEVEL adjustments which assists the user in matching the A/V system. Maximum level is 0.0dB, minimum level is -10.0dB relative to SPEAKER LEVEL adjustments.

Normally, with speakers set to LARGE the subwoofer is not active. The ENHANCED BASS option allows full range operation of the speakers with the additional bass contribution of the subwoofer. This feature is particularly useful when one wants to experience maximum bass output. Please note that due to acoustic cancellation effects, the bass response may be uneven when using this setting.

**Note:** The LFE and ENHANCED BASS options are part of the A/V Preset memories

### AUDIO DELAY

When connecting the M15 to a DLP projector, there may be a delay in the picture relative to the audio. In order to match this delay, the M15 allows up to 140ms of delay via 10ms increments.

**Note:** The AUDIO DELAY is not stored in memory, but is reset to 0.0 every time the M15 is switched to standby.

### THX AUTO

Select **THX AUTO** to ON when the post process decoding is to be THX controlled. When THX AUTO is set to ON then all Dolby and DTS decoding formats will automatically pass through the THX decoder.

**Note:** THX Ultra 2 decoding is dependent on the speaker configuration

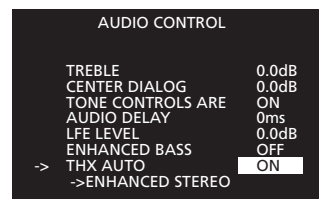
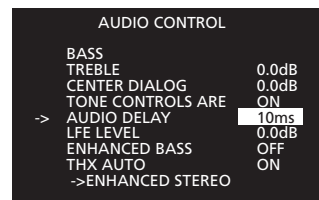
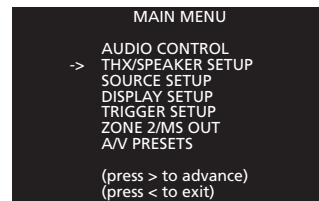

# Setup

## USING THE M15

```
MAIN MENU
-> AUDIO CONTROL
    THX/SPEAKER SETUP
    SOURCE SETUP
    DISPLAY SETUP
    TRIGGER SETUP
    ZONE 2/MS OUT
    A/V PRESETS

    (press > to advance)
    (press < to exit)
```

```
THX/SPEAKER SYSTEM
-> FRONT L+R  SMALL (THX)
    CENTER    SMALL (THX)
    SURROUND  2  SMALL (THX)
    SURR BACK 2  SMALL (THX)
    SUBWOOFER 1 THX ULTRA2
    LR+LFE XOVER THX 80Hz
    CENTER XOVER THX 80Hz
    SURR      XOVER THX 80Hz
    BASS FILTER THX
    ->NEXT (LEVEL)
```

```
SPEAKER LEVEL
-> FRONT LEFT  0.0dB
    CENTER      0.0dB
    FRONT RIGHT 0.0dB
    SURR RIGHT  0.0dB
    SURR BACK RIGHT 0.0dB
    SURR BACK LEFT 0.0dB
    SURR LEFT   0.0dB
    SUBWOOFER   0.0dB
    (for tone press TEST)
    ->NEXT (DISTANCE)
```

```
SPEAKER DISTANCE
-> FRONT LEFT  10ft
    CENTER      10ft
    FRONT RIGHT 10ft
    SURR RIGHT  10ft
    SURR BACK RIGHT 10ft
    SURR BACK LEFT 10ft
    SURR LEFT   10ft
    SUBWOOFER   10ft
    DISTANCE UNITS FT
    ->NEXT (THX ULTRA2)
```

```
THX ULTRA2
-> BOUNDARY GAIN COMPENSATION ON
    DISTANCE BETWEEN SBL+SBR SPEAKERS 6ft
```

```
THX ULTRA2
    BOUNDARY GAIN COMPENSATION ON
-> DISTANCE BETWEEN SBL+SBR SPEAKERS 6ft
```

### THX/SPEAKER SETUP

#### THX/SPEAKER SYSTEM

The following are your speaker selection options for the speaker size and filters. Press **ENTER** on the HTRM to save the speaker settings:

- FRONT L+R; SMALL (THX) or LARGE
- CENTER; SMALL (THX), LARGE, or NONE.
- SURROUND; 1 SMALL, 2 SMALL (THX), 1 LARGE, 2 LARGE, or NONE.
- SURR BACK (Surround Back); 1 SMALL, 2 SMALL (THX), 1 LARGE, 2 LARGE, or NONE.
- SUBWOOFER; 1, 1 SMALL (THX), 2, 2 SMALL (THX), or NONE.
- LR + LFE XOVER (Front Left and Right channel and the LFE); 60Hz, 70Hz, THX 80Hz, 90Hz, 100Hz, 110Hz, 120Hz
- CENTER XOVER; 60Hz, 70Hz, THX 80Hz, 90Hz, 100Hz, 110Hz, 120Hz
- SURR XOVER (Surround Channels Crossover frequency); 60Hz, 70Hz, THX 80Hz, 90Hz, 100Hz, 110Hz, 120Hz
- BASS FILTER (Crossover Frequency Slope); THX or 2ND ORDER

#### SPEAKER LEVEL

All speaker levels are adjustable from -12dB to +12dB. Press **ENTER** on the HTRM to save the level settings

#### SPEAKER DISTANCE

All speaker distances from the central listening point are adjustable from 0ft to 22ft (0m to 6.7m). Press **ENTER** on the HTRM to save the distance settings.

The speaker distance will be shown in either units feet or metres.

**Note:** If inappropriate speaker delays are set, a warning will display indicating too much time offset between Left and Right channels. The following warning will display;

“\*\* error! L/R delay > 2ms”

#### THX ULTRA2

Set the subwoofer **BOUNDARY GAIN COMPENSATION** to ON or OFF depending on whether you have one or two THX ULTRA2 subwoofers in close proximity to vertical surfaces. If a listener is sitting too close to a vertical surfaces their perception of the low frequencies is perceived as exaggerated. However, with The Boundary Gain Compensation filter applied to all output channels, the bass is equalized resulting in a flatter, more accurate bass response. Press **ENTER** on the HTRM to save the boundary gain settings.

**Note:** Boundary Gain Compensation is only available for THX ULTRA2 subwoofer selections.

#### DISTANCE BETWEEN SBL+SBR SPEAKERS

When you select two surround back speakers, set the distance between the two speakers in between 0ft to 22ft (0m to 6.7m). This setting will give correct spacial effect of the rear channels during THX Cinema, THX Surround EX, THX Music, and THX ULTRA2 decoding. Press **ENTER** on the HTRM to save the distance settings.

### THX BASS MANAGEMENT

For THX bass management to function, the speaker settings under THX SPEAKER SYSTEM must be set to THX values as per the indication of "THX" for each setting. If all settings are set to THX defaults, then THX and THX Ultra 2 will be available for THX bass management.

### THX GUIDELINES

When receiving a 5.1 Dolby stream and using the THX AUTO select mode from the AUDIO CONTROL OSD, then the following options are available:

#### 7.1 SPEAKER SYSTEM

For 5.1 Dolby Digital stream with THX AUTO set to OFF; The M15 will allow Ultra2 Cinema mode.

For 5.1 Dolby Digital stream with THX AUTO set to ON; The M15 will allow THX Surround EX mode.

#### 6.1 SPEAKER SYSTEM

For 5.1 Dolby Digital stream with THX AUTO set to OFF; The M15 will allow THX Cinema mode.

For 5.1 Dolby Digital stream with THX AUTO set to ON; The M15 will allow THX Surround EX mode.

#### 5.1 SPEAKER SYSTEM

For 5.1 Dolby Digital stream with THX AUTO set to OFF; The M15 will allow THX Cinema mode.

For 5.1 Dolby Digital stream with THX AUTO set to ON; The M15 will allow THX Cinema mode.

**Note:** the THX/RES button on the HTRM may be used to temporarily enable or disable the THX decoding format

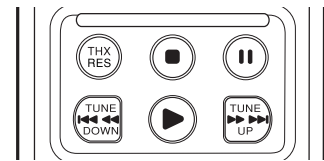

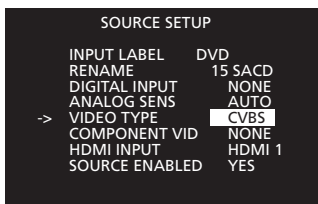
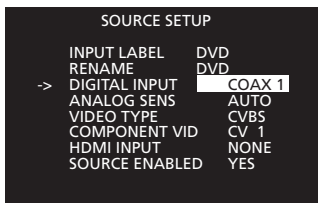
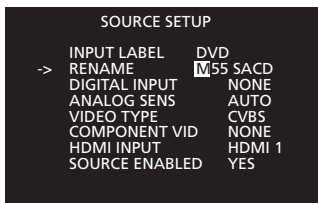
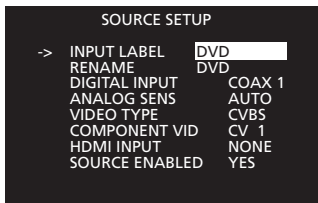

### SOURCE SETUP

#### INPUT LABEL (SOURCE SELECTION)

To edit the source selection and assignments of audio, video, and user delineable names, first select the input and then press **ENTER** on the HTRM. You will note that the M15 will automatically switch to this source allowing you real-time monitoring of the setup. All inputs are configurable in the SOURCE SETUP other than **ext 7.1** and **tape monitor**

**Note:** Assign the **ext 7.1** and **tape monitor** to any video input selection by first selecting the video input from **DVD** through to **VIDEO 6**, and then select the **ext 7.1** or **tape monitor** input from the M15's front panel (**7.1 IN** or **TAPE 0** on the HTRM remote control).

#### RENAME

You may assign a new label to the source inputs. This label will be shown in the VFD as well as the temporary OSD. There are 8 locations for the available for the following characters;

A-Z, a-z, [, ], -, <-, -, 0-9, :, ;,<, >, and, ?,

#### DIGITAL INPUT

The digital assignments available are the same that one can assign via the front panel, but in this OSD, the assignments are locked in memory;

NONE, COAXIAL 1, COAXIAL 2, COAXIAL 3, COAXIAL 4, OPT 1, OPT 2, OPT 3 and OPT 4.

#### DEFAULT DIGITAL INPUT ASSIGNMENTS

DVD	COAXIAL 1
SAT	COAXIAL 2
VCR	COAXIAL 3
VIDEO 4	COAXIAL 4
VIDEO 5	OPT 1
VIDEO 6	OPT 2
CD	OPT 3
DISC	OPT 4

#### ANALOG SENS (ANALOG GAIN SETTING)

Analog sensitivity gain settings can be fixed or variable;

0dB, -3dB, -6dB, or AUTO. Generally, for most situations, AUTO is the best setting.

#### VIDEO TYPE

There are two video types that may be assigned to the AV sources, CVBS and S-Video. These video types will be format converted to YUV for **MONITOR OUT**. There are two high definition video options assignable to each input, YUV and HDMI. For YUV output, the M15 will automatically format convert the CVBS and S-Video to YUV.

**Note:** The inputs **TUNER**, **DISC**, **CD**, **tape monitor** and **ext. 7.1** cannot be assigned S-Video nor CVBS video.

For optimal video performance, THX recommends bypassing video conversion (Composite Video in to Composite Video out, S-Video In to S-Video Out, Component Video In to Component Video Out).

**COMPONENT VID (VIDEO SELECTION)**

There are two YUV component outputs. The **MONITOR OUT** YUV includes the OSD. The **DIRECT MONITOR OUT** has no OSD. NAD recommends that one connects the **DIRECT MONITOR OUT** YUV to your monitor for NTSC (North American) video formats 480p/720p/1080i, and PAL (European) video formats 576p/720p/1080i.

**Note:** **MONITOR OUT** YUV which includes OSD, displays OSD when the input signal is NTSC video format 480i and PAL video format 576i.

Component video may be assigned to any of your sources. Options are NONE, CV-1, CV-2, and CV-3. These video inputs override VIDEO TYPE inputs. Thus select this input only if CVBS or S-Video are not to be used.

**HDMI INPUT (DIGITAL VIDEO SELECTION)**

HDMI video may be assigned to any of your sources. Options are NONE, HDMI-1, and HDMI-2. HDMI video may be assigned to any of your sources. These video inputs are available in parallel of VIDEO TYPE and COMPONENT VID inputs. Thus select this input only if HDMI is to be used. as both source and monitor.

**Note:** **HDMI OUT** does not include the M15's OSD. **HDMI OUT** is always active when a source has assigned **HDMI-1** or **HDMI-2**. See Quick Start figure 3 for monitor connection.

**SOURCE ENABLED**

One can enable/disable an unused input via this option. This is particularly useful if only a few inputs are used and one selects the inputs from the front panel controls, bypassing unused inputs.

**Note:** The HTRM will always give you direct access to any input even though it may have been disabled in the SETUP OSD.

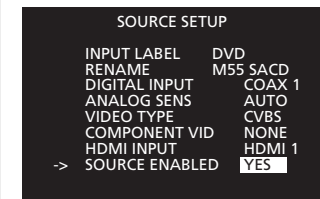
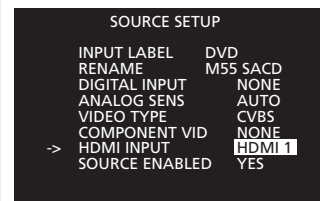
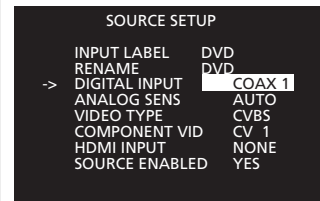

# Setup

## USING THE M15

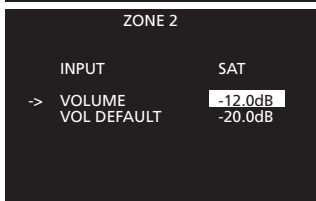
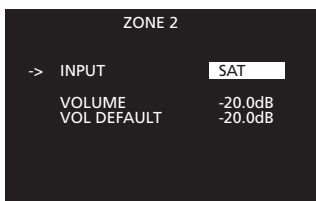
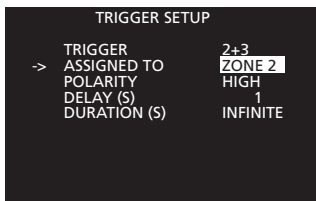
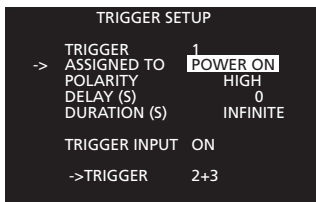
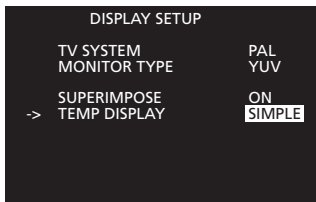
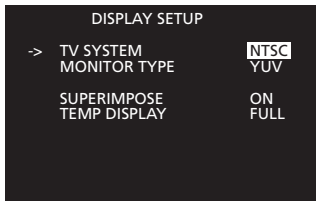

### DISPLAY SETUP

#### TV SYSTEM

Select between NTSC and PAL systems. Select NTSC (North American) or PAL (European) TV System in order to view the OSD on your monitor. This setting only affects the OSD, the source material will be displayed in its native format.

#### MONITOR TYPE

This setting sets the MONITOR OUT of the M15. Select between YUV, S-Video and CVBS. For source inputs using both S-Video and CVBS, only YUV is available.

#### SUPERIMPOSE

You may superimpose the Setup OSD over any existing video by selecting ON. The OFF setting places the OSD over a black background.

#### TEMP DISPLAY (TEMPORARY OSD)

One may display the operating state of the M15 temporarily by setting this variable to FULL. Otherwise when the variable is set to SIMPLE only the volume OSD will display. A setting of OFF will disable the temporary OSD.

**Note:** To display a temporary OSD on the **MS OUT COMPOSITE VIDEO**, the TEMP DISPLAY may be set to SIMPLE or FULL.

### TRIGGER SETUP

#### TRIGGER 1 & TRIGGER 2+3

There are two trigger assignments, Trigger 1 and Trigger 2+3. The trigger outputs can be assigned to; POWER ON, ZONE 2, DVD, SAT, VCR, Video 4, Video 5, Video 6, Disc, CD, and Tuner.

#### POLARITY

One may assign the steady-state of the trigger polarity to either POLARITY variables HIGH or LOW. This steady-state polarity is the 'active' final state of the trigger output signal.

#### DELAY (S)

The delay between when one selects the assignment either from the front panel or HTRM remote, to when the trigger signal will transition. The values are in seconds, set from 0, 1, or 5 seconds.

#### DURATION (S)

The duration of the steady state may be set in seconds from 1, 5, 10, 30, to INFINITE.

#### TRIGGER INPUT

when the TRIGGER INPUT is set to ON, the M15 will turn on from the standby state when a DC +12V signal is present at the **TRIGGER IN** socket. As long as the signal is present the M15 will remain in the ON state. When the +12V signal is absent, the M15 will revert to its standby state.

**Note:** The front panel button or the HTRM remote control can override the **TRIGGER IN** signal

### ZONE 2/MS OUT

#### INPUT

Using the HTRM remote, select an input to display on the **ZONE 2/MS OUT** via this OSD menu. All inputs other than tape monitor and ext. 7.1 can be selected at the **ZONE 2/MS OUT** using your HTRM remote control in the main zone.

#### VOLUME

This volume setting is the temporary volume setting of the ZONE 2/MS OUT via HTRM remote control. Adjust the level using the HTRM's navigation arrows ▲ or ▼ from mute to +12 dB.

#### VOL DEFAULT (START UP ZONE 2 VOLUME)

This volume setting is the default volume setting from standby. The level may be set from mute to +12 dB using the same navigation arrows above. To store the value one must press the HTRM's **ENTER** button.



**ENHANCED STEREO**

ENHANCED STEREO is useful when maximum audio levels are required from all channels. The default for ENHANCED STEREO is with all speakers set to ON. The stereo image may be redirected to any set or all of the speakers.

For example, it is possible to redirect the stereo image from front to surround or rear speakers through the setup OSD:

- Press ENTER on the HTRM remote, select AUDIO SETUP, and then scroll to ENHANCED STEREO.
- Press the right navigation arrow ► to advance to the next menu.
- Scroll to the set of speakers you want ON or OFF, then press the navigation arrow ► to enter the line item to edit.
- Then select ON or OFF using the navigation arrows ▲/▼, and then ENTER on the HTRM remote.

**A/V PRESETS**

There are five A/V Presets permanently stored in the M15's memory. As default, access to the presets is via the number keys 1 through Preset 5. Using the HTRM remote control press the **A/V PSET** button and then the number buttons 1 through 5; the OSD will indicate the preset number chosen.

**SETTING UP AUDIO/VIDEO PRESETS**

A/V Presets are stored automatically as one enters each variable change in the M15's OSD. These variables are;

- THX/SPEAKER SYSTEM (the number of speakers)
- SPEAKER LEVEL (the level of all speakers relative to the listener)
- SPEAKER DISTANCE (the distance of all speakers relative to the listener)
- THX ULTRA 2 settings
- ENHANCED BASS (large speakers receive full bass response with subwoofer on)
- LFE LEVEL (attenuation setting)

To program an A/V Preset, select on the HTRM **A/VPSET** and then the number **1** through to **5**. Then enter the M15's OSD menu by pressing the HTRM's **ENTER** button. Once in the M15's OSD change the variables as mentioned above.

**Note:** not all OSD variables that are stored by pressing the HTRM's **ENTER** button are part of the A/V Preset, only those mentioned above.

A/V Preset 1 is the default preset for any source input not assigned to an A/V Preset.

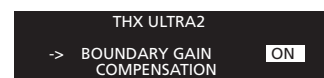
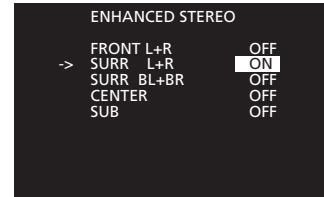
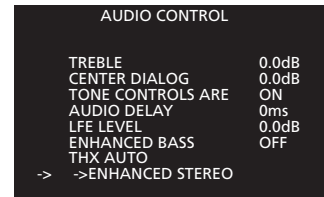

A/V PRESETS		LINK TO:
-> PRESET 1	[DEFAULT]	DVD
PRESET 2	NONE	
PRESET 3	NONE	
PRESET 4	NONE	
PRESET 5	NONE	
CURRENT PRESET	1	
COPY TO PRESET	1	

A/V PRESETS		LINK TO:
PRESET 1	[DEFAULT]	DVD
PRESET 2	VCR	
PRESET 3	SAT	
PRESET 4	CD	
PRESET 5	NONE	
-> CURRENT PRESET	1	
COPY TO PRESET	1	

A/V PRESETS		LINK TO:
PRESET 1	[DEFAULT]	DVD
PRESET 2	VCR	
PRESET 3	SAT	
PRESET 4	CD	
PRESET 5	NONE	
-> CURRENT PRESET	1	
COPY TO PRESET	2	

### ASSIGNING A/V PRESETS

Link each A/V Preset to a source input to make it easy for you to select the A/V Preset simply by the press of an HTRM's source input. The following is the procedure for assigning A/V Presets to a source input:

- Press **ENTER** from the HTRM remote control, then using the **▲/▼** buttons select A/V PRESETS, and then press the **▶** button to enter the A/V PRESETS OSD
- Once in the A/V PRESETS OSD, select the A/V Preset you would like to assign by pressing A/V PSET and the number on the HTRM remote control. The menu item "CURRENT PRESET #" will show you the A/V Preset you have selected.
- Using the **▲/▼** buttons, navigate to the "PRESET #" you want to assign and then press the **▶** to enter the variable window. Press the **▲/▼** navigation buttons to scroll through the M15's source input and then press the **ENTER** button. Continue this process to assign each preset a source input as per you're A/V system requirements.

### COPYING A/V PRESETS

During the naming of any A/V Preset, one may copy an existing A/V PRESET to another. This is particularly useful when setting up the A/V system for the first time so that one does not need to setup all speakers' settings for each assignment.

- Press **ENTER** from the HTRM remote control, then using the **▲/▼** buttons select A/V PRESETS, and then press the **▶** button to enter the A/V PRESETS OSD
- Either press **A/PSET** and then the number **1** through **5** on the HTRM, or navigate to the CURRENT PRESET # and using the HTRM's navigation arrows **▲/▼** select the A/V preset. Press **ENTER** from the HTRM remote control.
- From the HTRM, navigate to the "COPY TO PRESET #" and then press **▶**. Then using the HTRM's **▲/▼** arrows select the target A/V Preset number. Press **ENTER** from the HTRM remote control.

**Notes:** The user's calibrated A/V system is always A/V PRESET 1.

The M15 will remember the last selected source-assigned A/V Preset, even when powered **OFF** from the rear **POWER** switch.

A/V Preset 1 is the default preset for any source input not assigned to an A/V Preset.

To restore factory default A/V Preset settings; from the M15's front panel simultaneously press **audio** and **d/a selector** for North American defaults, or press **video** and **d/a selector** for European defaults, and then follow the instructions on the VFD in either case.

CONDITION	POSSIBLE CAUSE(S)	POSSIBLE SOLUTIONS(S)
<b>NO SOUND FROM ALL CHANNELS</b>	<ul style="list-style-type: none"> <li>AC power unplugged</li> <li>power not switched on</li> <li>outlet is un-powered</li> <li>Tape Monitor is engaged</li> </ul>	<ul style="list-style-type: none"> <li>Check AC cable, connection, and outlet</li> <li>Disengage Tape Monitor</li> </ul>
<b>NO SOUND FROM SOME CHANNELS</b>	<ul style="list-style-type: none"> <li>Faulty/missing cables</li> <li>THX/SPEAKER SETUP channel(s) set to "NONE"</li> <li>Power-amp or speaker-connections faulty</li> </ul>	<ul style="list-style-type: none"> <li>Check cables</li> <li>Check THX/SPEAKER SETUP menu</li> <li>Check power amp, cabling, and speakers</li> </ul>
<b>NO SOUND FROM SURROUND CHANNELS</b>	<ul style="list-style-type: none"> <li>No surround listening mode is engaged</li> <li>surround-channels set to "NONE" on THX/SPEAKER SETUP menu</li> <li>Surround-channels level set too low on SPEAKER LEVEL menu</li> </ul>	<ul style="list-style-type: none"> <li>Select appropriate listening mode</li> <li>Correct THX/SPEAKER SETUP or SPEAKER LEVEL settings</li> </ul>
<b>NO SOUND FROM SUBWOOFER</b>	<ul style="list-style-type: none"> <li>Subwoofer is off, unpowered, or improperly connected</li> <li>Subwoofer set to "NONE" on THX/SPEAKER SETUP menu</li> <li>Subwoofer level set too low on THX/SPEAKER SETUP menu</li> </ul>	<ul style="list-style-type: none"> <li>Power-up subwoofer, check sub's AC outlet or check connections</li> <li>Correct THX/SPEAKER SETUP or LEVEL SETUP settings</li> </ul>
<b>NO SOUND FROM CENTER CHANNEL</b>	<ul style="list-style-type: none"> <li>Source is a 2/0 (etc.) Dolby Digital or DTS recording without center channel</li> <li>Center set to NONE on THX/SPEAKER SETUP menu</li> <li>Center level set too low on THX/SPEAKER SETUP MENU</li> </ul>	<ul style="list-style-type: none"> <li>Play a known 5.1-channel recording or select Dolby Pro Logic or Mono mode</li> <li>Correct THX/SPEAKER SETUP or LEVEL SETUP settings</li> </ul>
<b>NO DOLBY DIGITAL/DTS</b>	<ul style="list-style-type: none"> <li>Source's digital output is not connected to an M15's digital input</li> </ul>	<ul style="list-style-type: none"> <li>Check connections</li> </ul>
<b>M15 DOES NOT RESPOND TO HTRM REMOTE OR ZR2 REMOTE</b>	<ul style="list-style-type: none"> <li>Batteries are flat or incorrectly inserted</li> <li>IR transmitter window on remote, or IR receiver window on M15 is obstructed</li> <li>M15 front panel is in very bright sunlight or ambient light</li> </ul>	<ul style="list-style-type: none"> <li>Check batteries</li> <li>check IR windows and ensure clear line-of-sight from remote to M15</li> <li>reduce sunlight/room lighting</li> </ul>
<b>NO OSD OSD IS SCROLLING OSD AND VIDEO IS DISTORTED OR BLANKING</b>	<ul style="list-style-type: none"> <li>Source video type is not 480i or 576i</li> <li>Monitor/TV is connected <b>COMPONENT VIDEO DIRECT</b></li> <li>M15 is connected to <b>HDMI OUT</b></li> </ul>	<ul style="list-style-type: none"> <li>Set the video source such as DVD-player to 480i (NTSC) or 576i (PAL)</li> <li>Connect the Monitor/TV to <b>COMPONENT VIDEO MONITOR OUT.</b></li> <li>Use <b>COMPONENT VIDEO MONITOR OUT</b> to view OSD</li> </ul>

## FACTORY DEFAULT SETTINGS

In the event that the M15 may become configured inappropriately or become non-responsive the factory default settings can be set by the front panel buttons as follows;

- To set the factory default settings for 120V version simultaneously press the M15's front panel buttons **audio** and **a/d selector**.
- To set the factory default settings for Factory default settings for 230V version simultaneously press the M15's front panel buttons **video** and **a/d selector**.

**Note:** Setting the M15 to factory default settings will erase any stored AV Presets and source input renaming.

## HTRM SPECIAL FUNCTIONS

### SOFTWARE VERSION NUMBER

- Press simultaneously the **ON + TEST** buttons for five seconds to display version numbers.

### LIGHT SENSOR CALIBRATION MODE

- Press simultaneously the **ENTER + SETUP** buttons for five seconds to enter the setup menu. Then scroll down to "B Light", press **ENTER**, then scroll down to "Sens Lvl" and press **ENTER**, you are now in the light sensor calibration mode:
- You will see displayed on the first line of the LCD where #### is the reading (0 - 1023) from the light sensor. The second line shows a bar graph representing the reading.
- Press the **ENTER** key to exit this mode. A confirmation will be displayed. Select "Yes" or "No" to set the new value.

**DECODING FORMATS**

Dolby Digital, Dolby Digital EX, Dolby Pro Logic II, Dolby Pro Logic IIx, DTS, DTS ES, DTS Neo:6, DTS 96/24, THX Surround EX, THX Ultra 2

**SAMPLING RATES**

32kHz, 44.1kHz, 48kHz, 88.2k, 96kHz

**MODES**

EARS, Enhanced stereo, Mono

**VIDEO**

Input and output impedance 75Ω

**THX + NOISE**

0.002%

**PRE-AMP SECTION**

**LINE LEVEL INPUTS**

Input impedance (R+C)	56kΩ/180pF
Frequency response (20Hz to 20kHz)	20Hz to 20kHz @ +/-0.3dB

**LINE LEVEL OUTPUTS**

Output impedance	470Ω
Tape	Source Z + 2kΩ
Signal/noise ratio	>102dB
Maximum Output Level.	6Vrms
Multiroom Output (Zone 2)	470Ω

**TONE CONTROLS**

Bass	±10dB@20Hz
Treble	±10dB@20kHz
Center Dialog	±6dB@1kHz

**+12VOLT TRIGGER OUT**

Output Voltage	+12V +/- 20%
Minimum Output Current	>40ma
Maximum Short Circuit Current	<60mA

**PHYSICAL SPECIFICATIONS**

Dimensions (W x H x D)	Net	17.13 x 5.24 x 13.98" (435 x 133 x 355mm)
	Gross*	17.13 x 5.79 x 14.96" (435 x 147 x 380mm)
Net Weight		15 lbs
Shipping Weight		20 lbs

\*Gross dimensions include feet, volume knob, power button and extended speaker terminals. Specifications are subject to change without notice. For updated documentation and features please log onto [www.nadelectronics.com](http://www.nadelectronics.com) for the latest information about your M15.





[www.NADelectronics.com](http://www.NADelectronics.com)

**©2005 NAD ELECTRONICS INTERNATIONAL  
A DIVISION OF LENBROOK INDUSTRIES LIMITED**

All rights reserved. No part of this publication may be reproduced, stored or transmitted in any form without the written permission of NAD Electronics International

M15 Manual 11/2005